

Kit 3047

NISSAN Primastar, 4/5-dr Van, 02-06, 07–

OPEL Vivaro, 2-dr Single cab, 01-06, 07–

OPEL Vivaro, 4/5-dr Van, 01-06, 07–

RENAULT Trafic, 2-dr Single cab, 01-06

RENAULT Trafic, 4/5-dr Van, 01-06, 07–

This Kit is only for vehicles with fixpoint mounting.

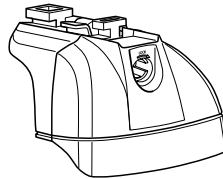

**460R
753**

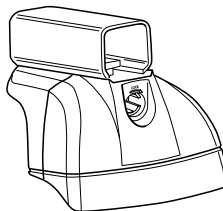
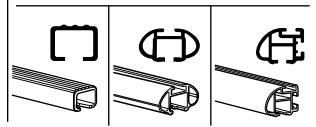

460

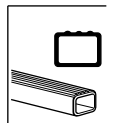

THULE[®]
SWEDEN

ISO 11154-E

6 kg / 13 lbs + xx kg xx lbs =

Max.
100 kg
Max.
220 lbs

9 kg / 20 lbs + xx kg xx lbs =

Max.
150 kg
Max.
330 lbs

12 kg / 26 lbs + xx kg xx lbs =

Max.
200 kg
Max.
440 lbs

Kit

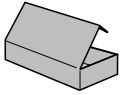

753

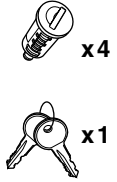
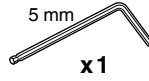
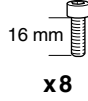
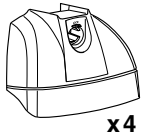
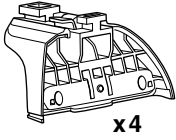

460R

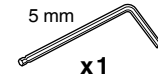
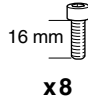
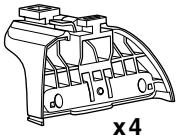

460

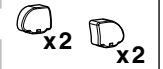
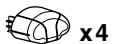
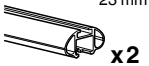
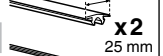
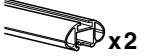
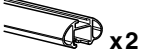
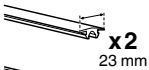
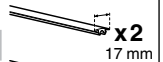
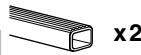
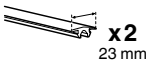
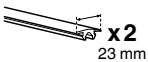
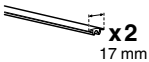
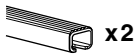
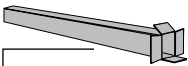
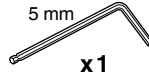
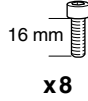
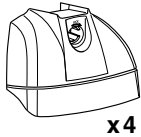
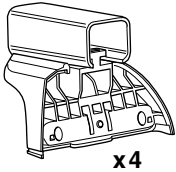

1

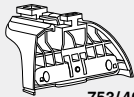

753/460R

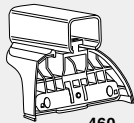

460

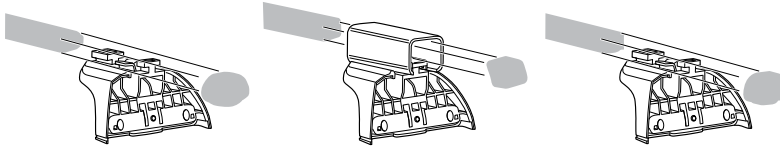

x4

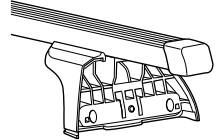
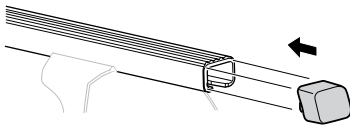

x4

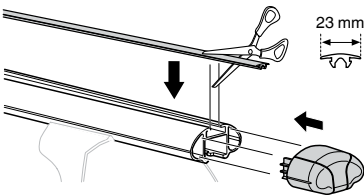

23 mm

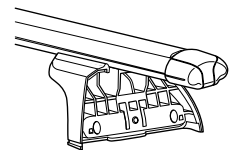
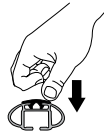

x4

x4

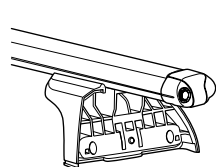
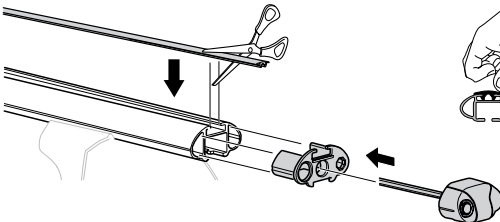

x4

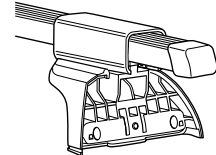
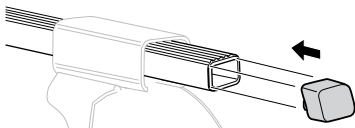

x2

x2

x4

x4

x1
5 mm

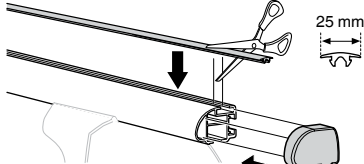

25 mm

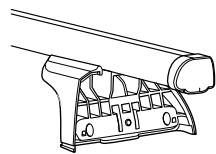
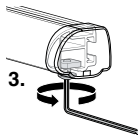
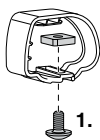
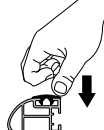

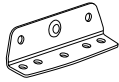
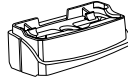
2**04** x 4**61** x 116 mm  x 8

x 1

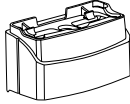
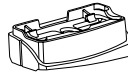
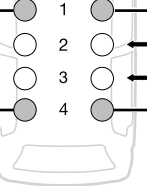
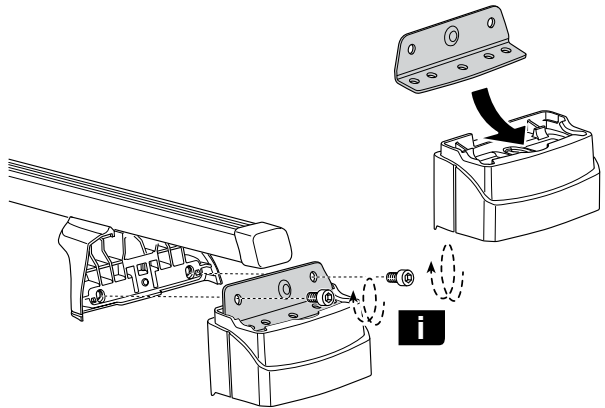
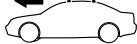
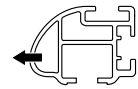
**60** x 2**62** x 1**04****62****04****61****Kit 3046****Kit 3046****04****60****04****06****i**

- GB** Only a few turns
D Nur wenige Umdrehungen
F Quelques tours uniquement
NL Slechts enkele slagen
I Solo qualche giro
E Sólo algunas vueltas
PT Noções básicas
S Endast några varv
FIN Vain muutama kierros
EST Ainult mõni pööre
LAT Tikai dažī apgriezieni
LIT Tik keli pasukimai
PL Wystarczy kilka obrotów
RU Достаточно нескольких оборотов
CZ Pouze několik otáček
SK Len niekoľko otáčok
SLO Le nekaj obratov

- HR** Samo nekoliko okreta
HU Csak néhány fordítás
GR Μόνο μερικές στροφές
TR Yalnız birkaç kez çevirm
中文 只有几个转向
한국어 두 세번만
日本語 数回転のみ
ไทย หมุนเพียงไม่กี่รอบ

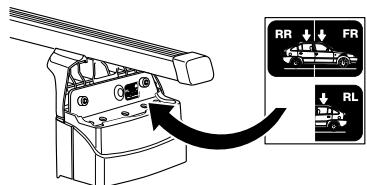

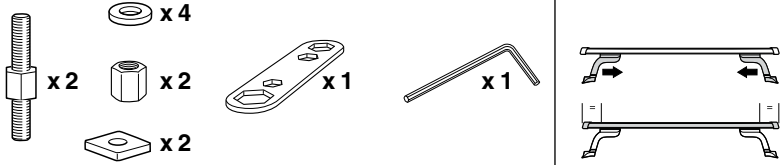
3**NISSAN Primastar,**

4/5-dr Van, 02-06, 07-

OPEL Vivaro,

2-dr Single cab, 01-06, 07-

OPEL Vivaro,

4/5-dr Van, 01-06, 07-

RENAULT Trafic,

2-dr Single cab, 01-06

RENAULT Trafic,

4/5-dr Van, 01-06, 07-

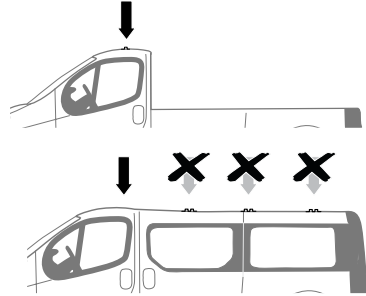
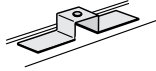
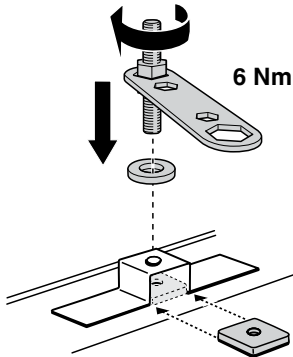
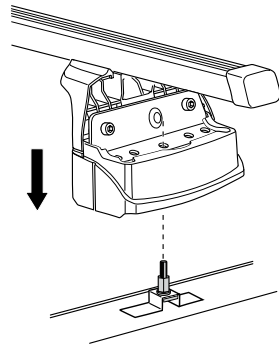
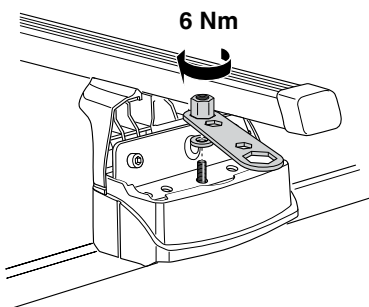
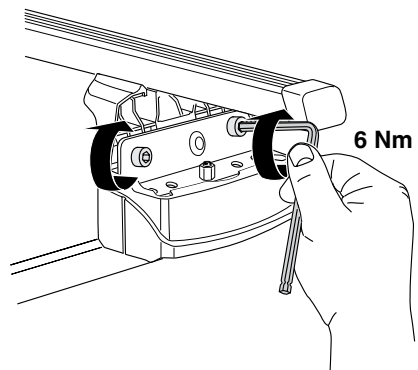
**A****B****C****D**

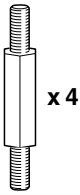
3

x 4



x 8



x 4



x 4

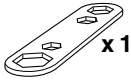

x 1

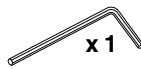

x 1

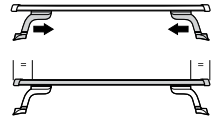
**NISSAN Primastar,**

4/5-dr Van, 02-06, 07-

OPEL Vivaro,

4/5-dr Van, 01-06, 07-

RENAULT Trafic,

4/5-dr Van, 01-06, 07-

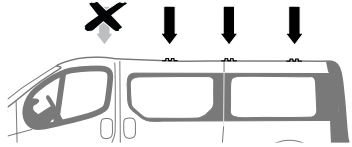
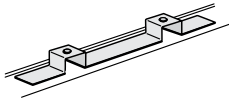
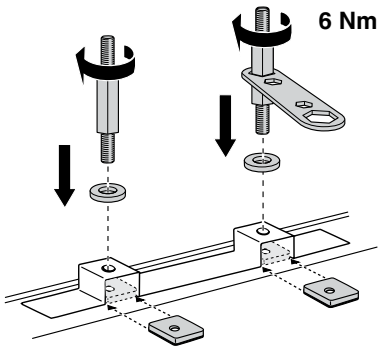
**A**

6 Nm

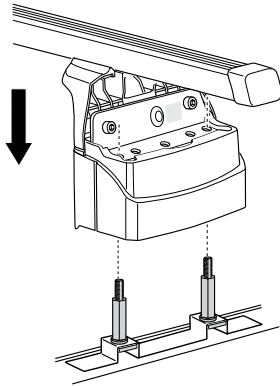
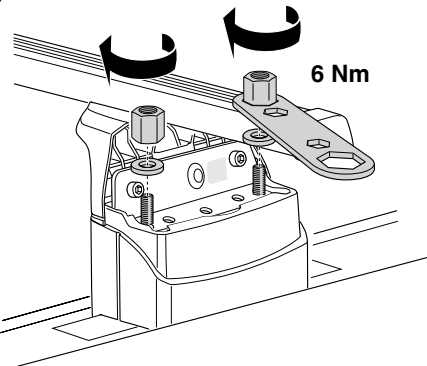
B**C**

6 Nm

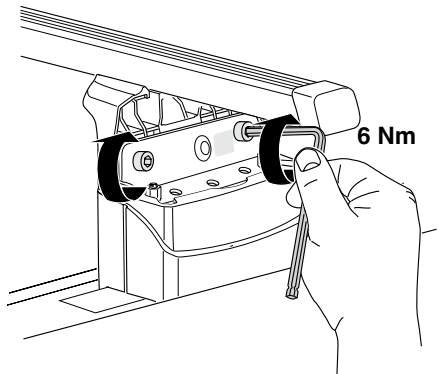
D

6 Nm

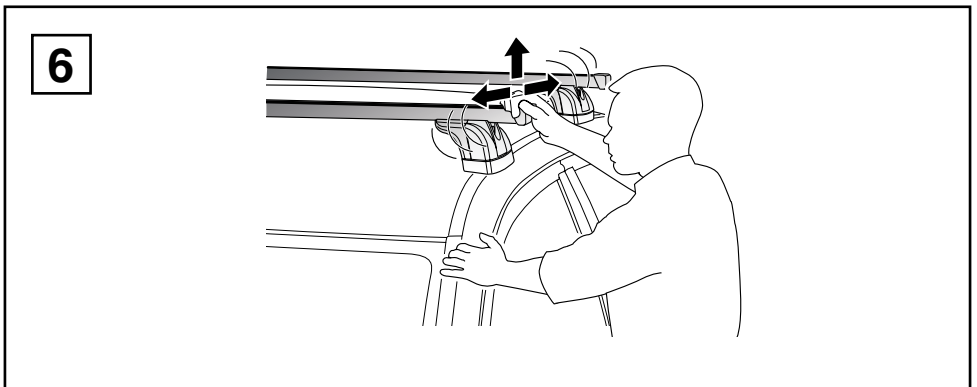
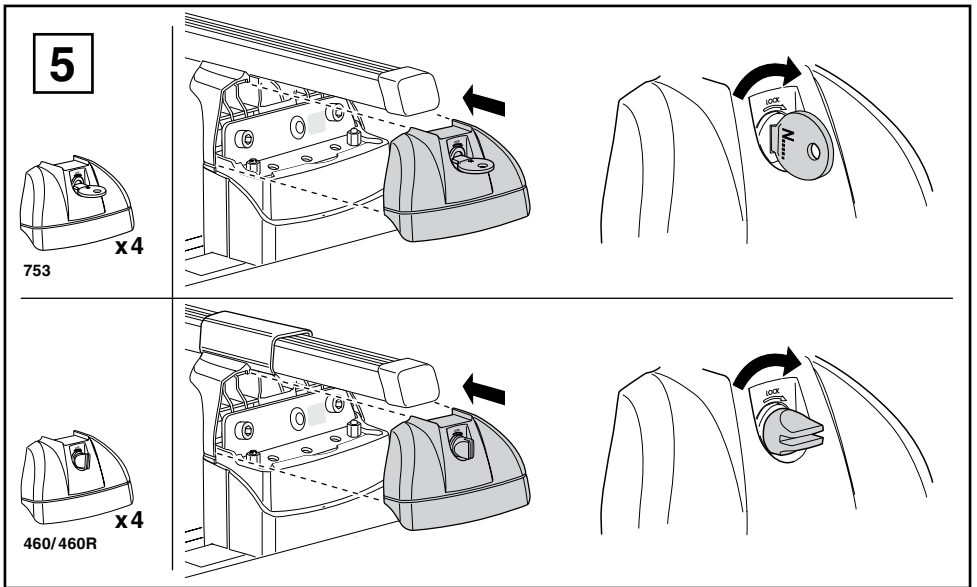
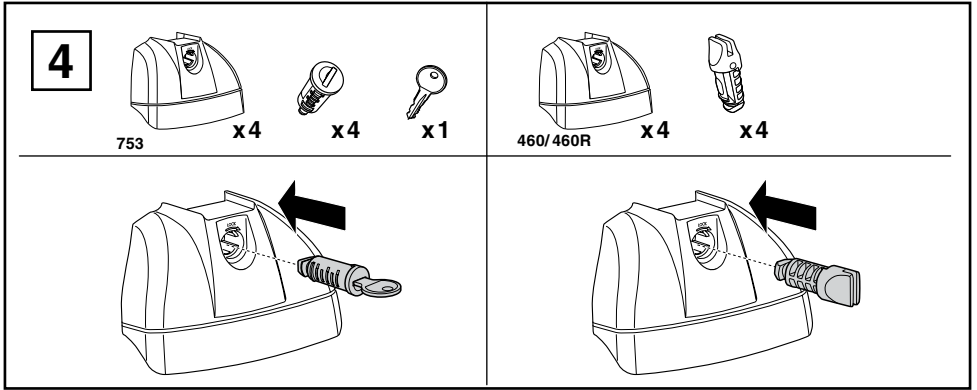

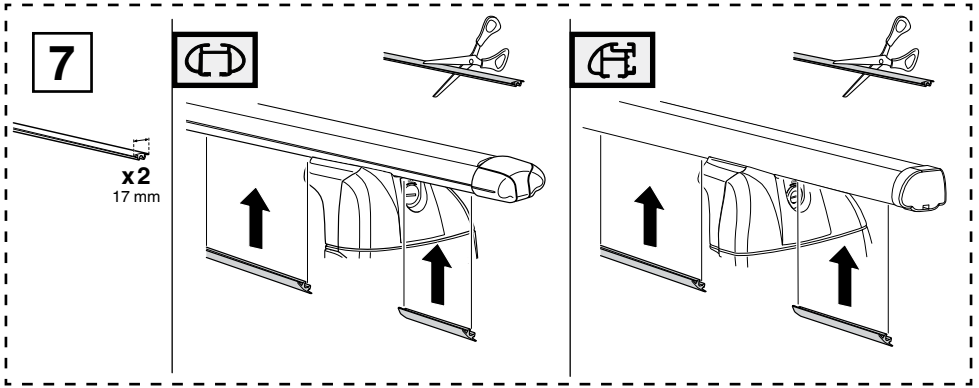

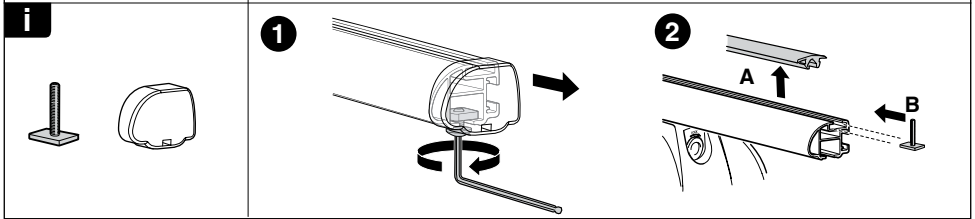
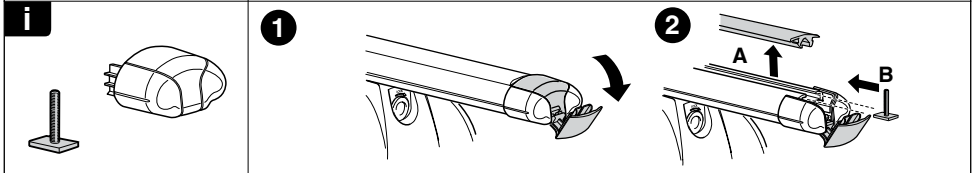
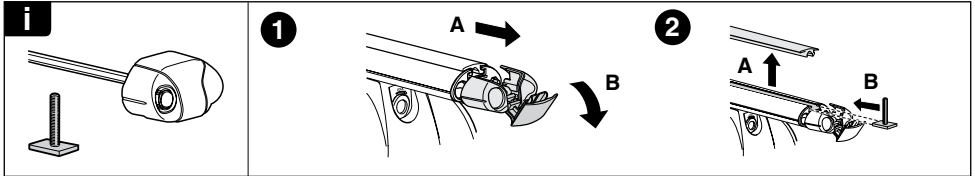
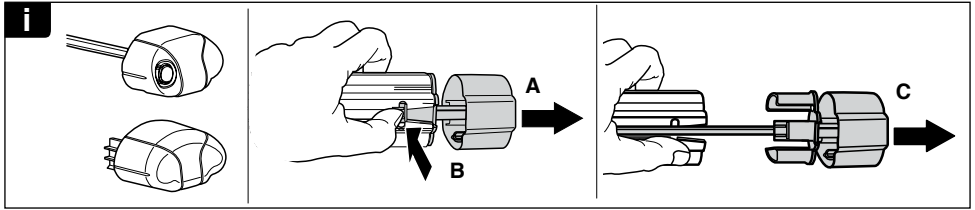



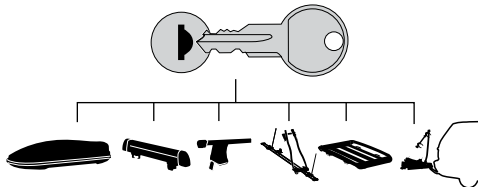

THULE
SWEDEN
**ONE
KEY
SYSTEM**



-  544 (x4)
-  596 (x6)
-  588 (x8)
-  NA 510 (x10)
-  EUR 452 (x12)

WW ▶ Thule Sweden AB, Box 69, 330 33 Hillerstorp, SWEDEN
NA ▶ Thule Inc., 42 Silvermine Road, Seymour, Connecticut 06483, USA

info@thule.com
customer.service@thule.com

 www.thule.com
506-3047-02